

Article number: 203180M24100C4V

Description: E+G levelling foot
GN 31-80-M24-100-C4-V

Note: V Without nut, External hexagon at the top, Wrench flat at the bottom

Measures

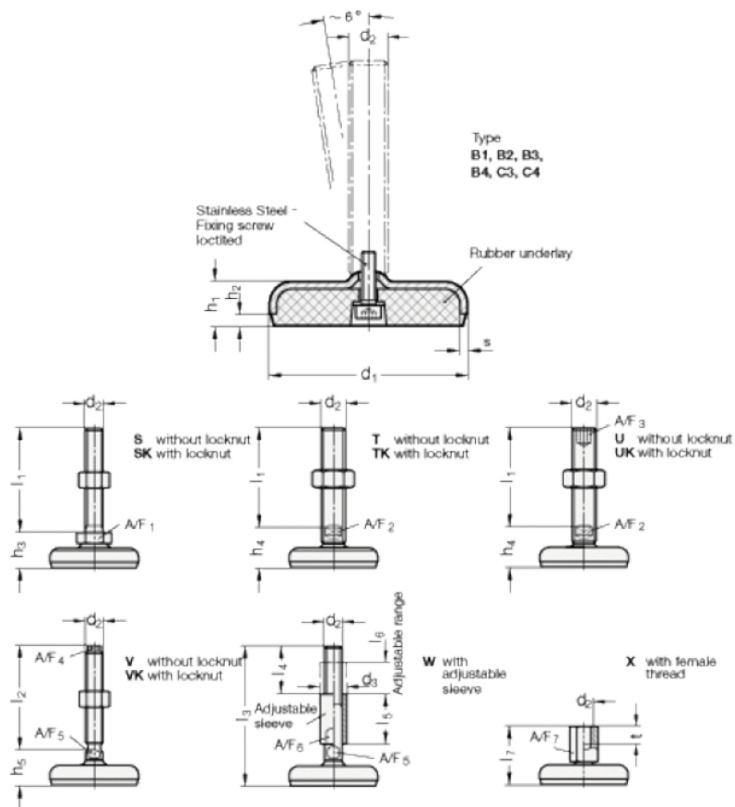

A/F4	= 17	s = 3
A/F5	= 20	
d1	= 80	
d2	= 24	
h1	= 18	
h2	= 5	
h5 +4.0/0	= 33	
l2	= 100	